

BOXmanufaktur

BoXmanufaktur Concepts

**Mercedes-Benz
Unimog**



Ready for Adventure?





**Windows
Hatches & Doors**





**Access to the
driver's cab**





Subframe





**Box Installation
& Twist Test**





Interior

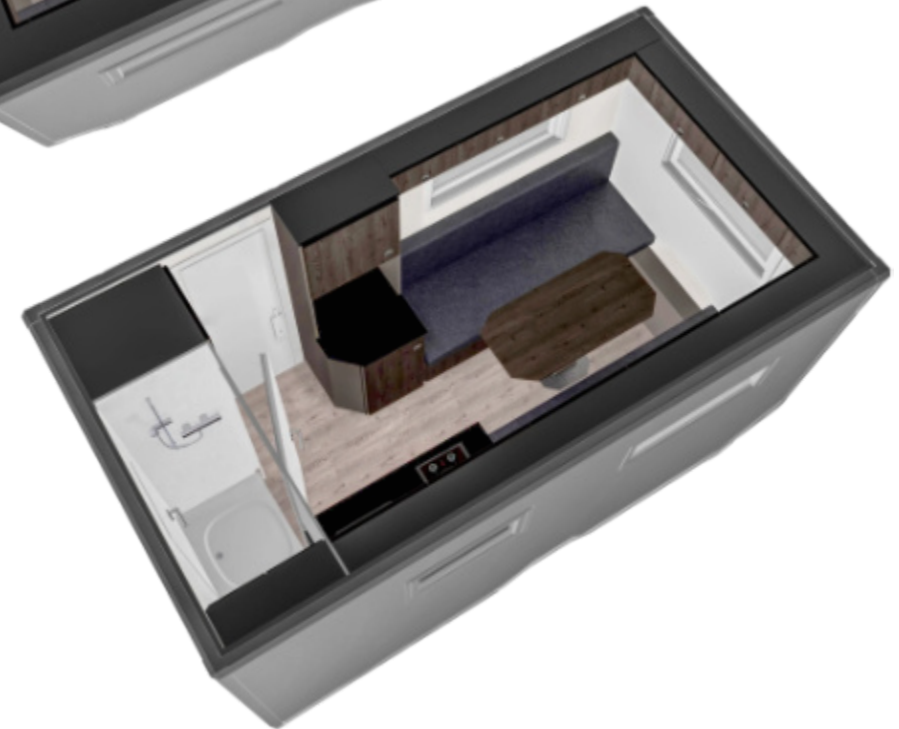
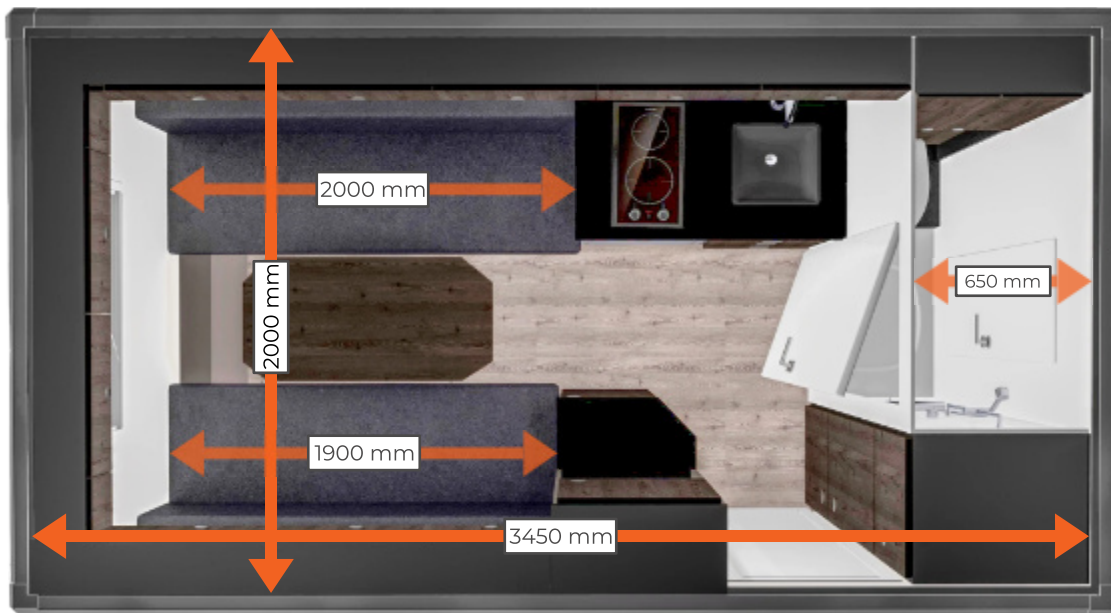

MB Unimog U1300

- 2 persons
- 2 single beds, expandable to a double bed
- 42 mm wall thickness
- Dometic windows

Day 

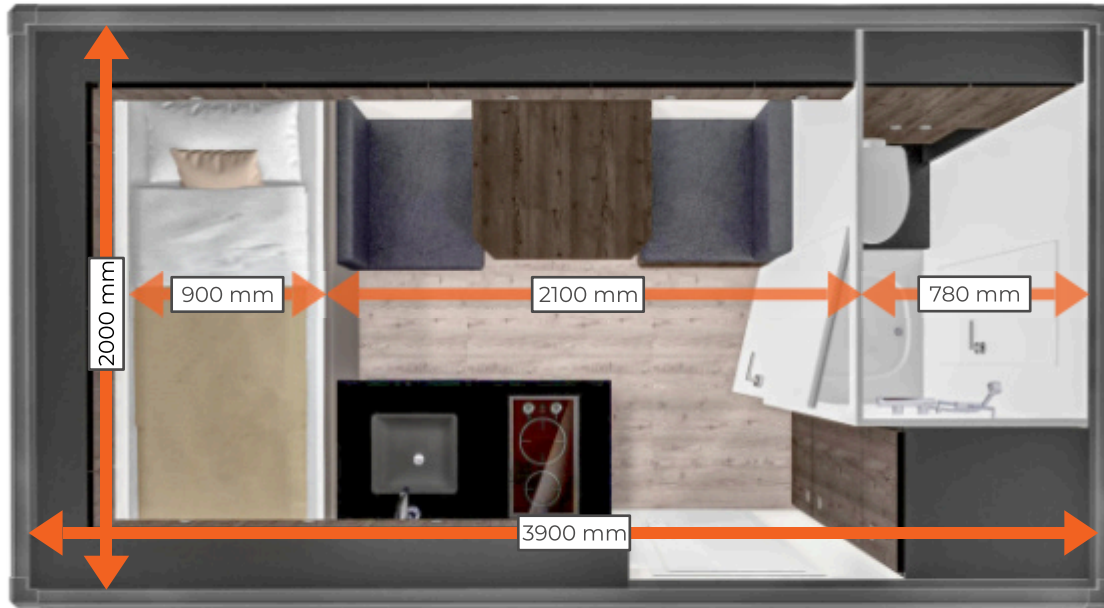

Night 



MB Unimog U1300/ 1550

- 2 persons
- Extendable double bed
- 42 mm wall thickness
- Dometic windows



Day 

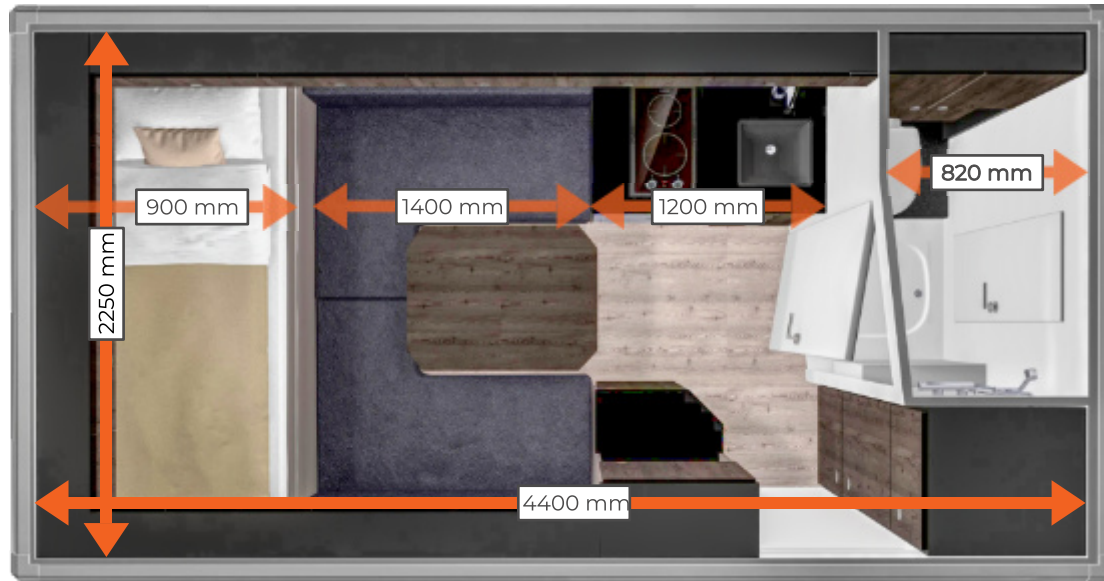

Night 



MB Unimog U4023/ 5023

- 2 persons
- Extendable double bed
- 59 mm wall thickness
- KCT or Outbound windows (Other manufacturers possible)

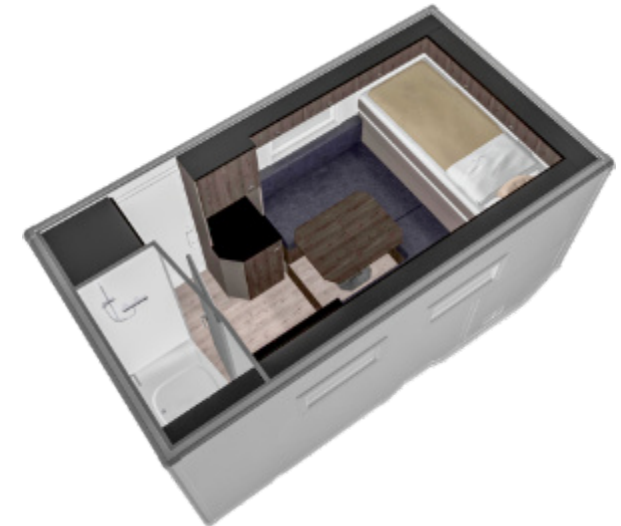

MB Unimog U4023/ 5023

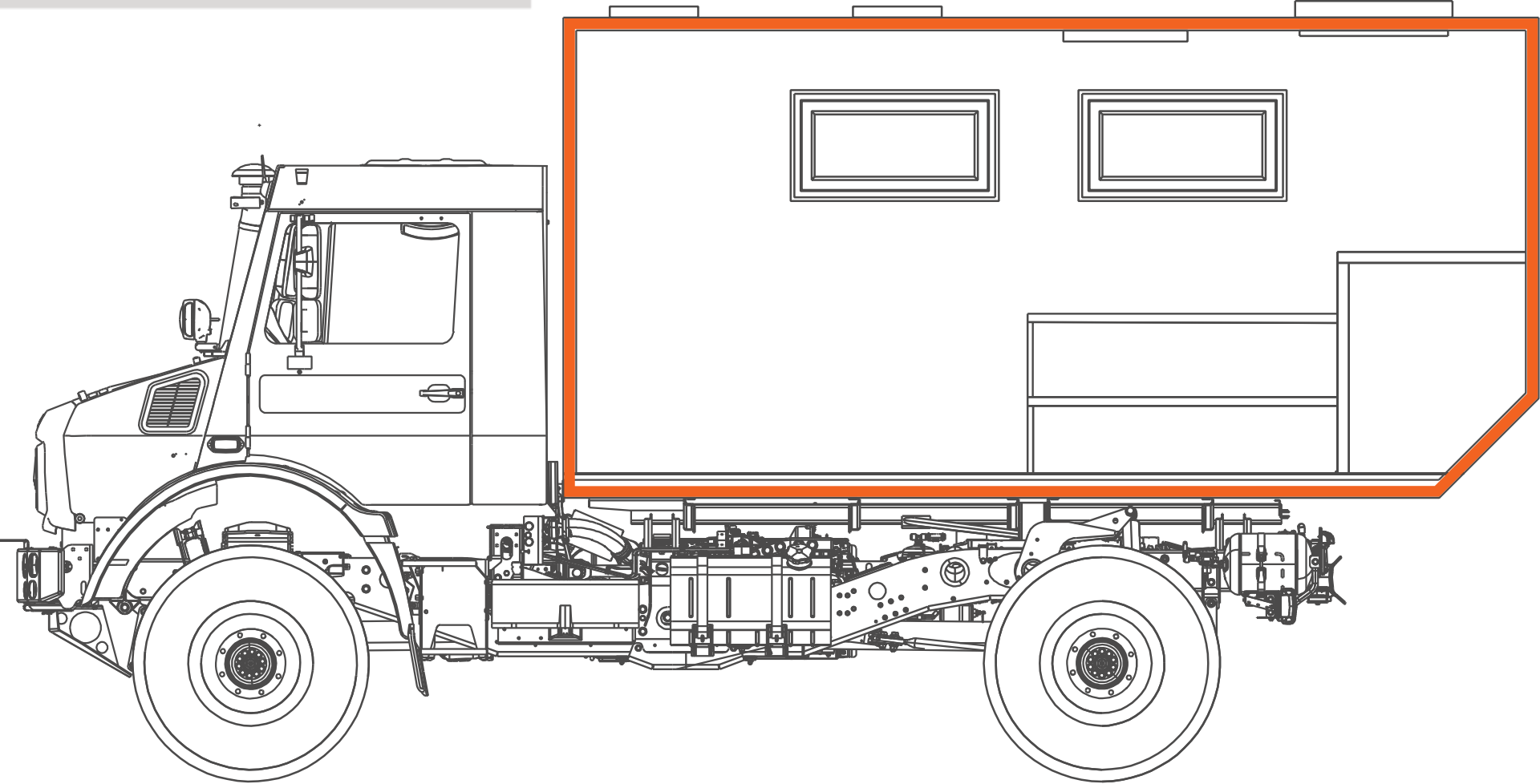











Exterior



Individual Cargo Carrier & Roof Racks - Roof Rails - Branch Deflectors



Custom Entry Solutions



Integrated Wheel Arches - Under Body Storage Boxes - Traction Boards Carrier

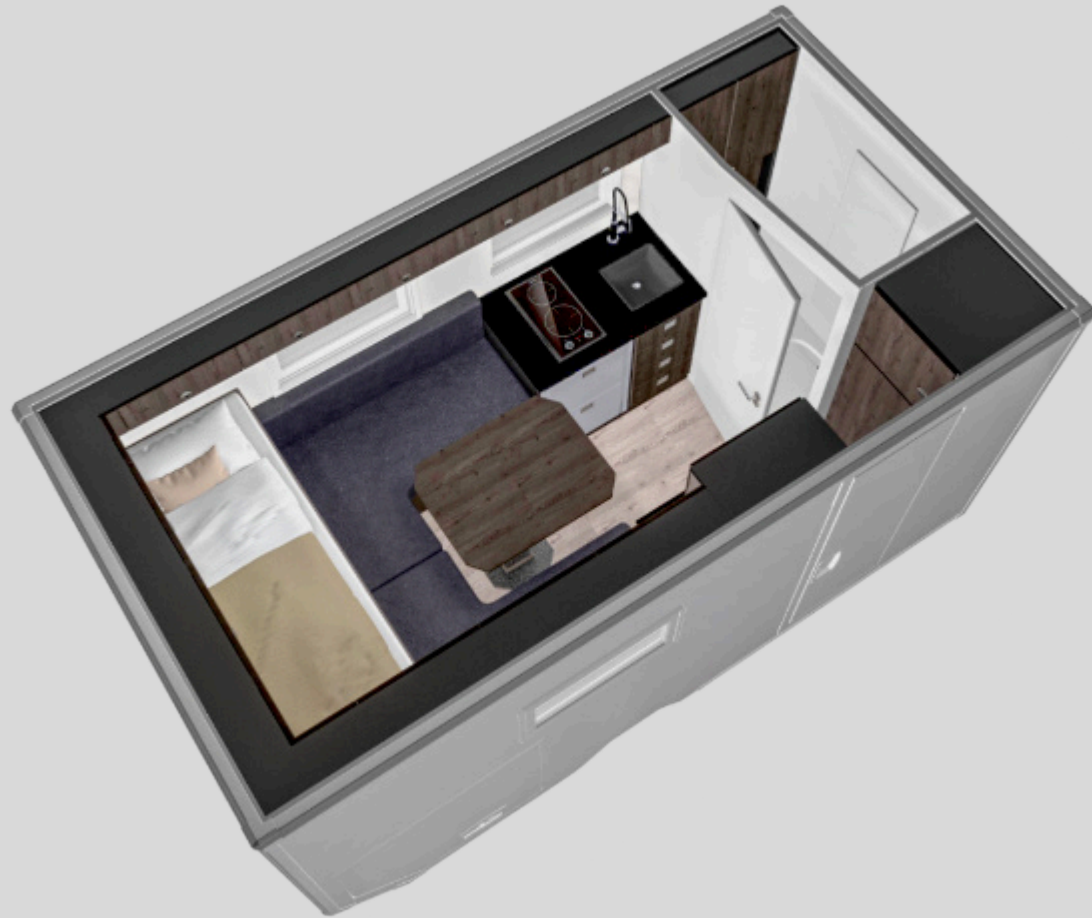

BOX *manufaktur*

BoXmanufaktur UG

Bremerstr. 24-26

27367 Sottrum

+49 4264. 40 62 05

sales@boxmanufaktur.com

www.boxmanufaktur.com